

**ELECTROSTATIC SENSITIVE DEVICE**  
OBSERVE HANDLING PRECAUTIONS

MITSUBISHI RF POWER MOS FET

# RD16HHF1

Silicon MOSFET Power Transistor 30MHz,16W

## DESCRIPTION

RD16HHF1 is a MOS FET type transistor specifically designed for HF RF power amplifiers applications.

## FEATURES

- High power gain:  
Pout>16W, Gp>16dB @Vdd=12.5V,f=30MHz

## APPLICATION

For output stage of high power amplifiers in HF band mobile radio sets.

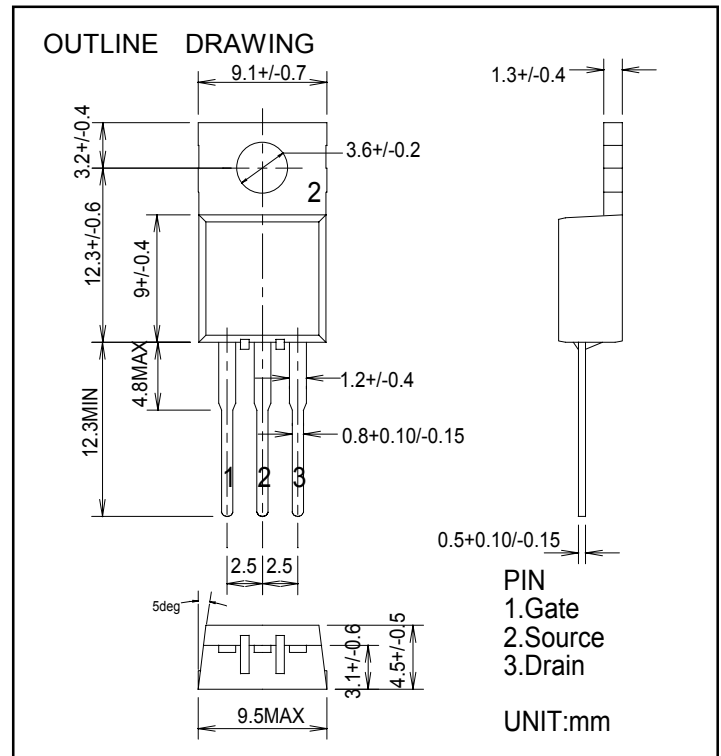

## ABSOLUTE MAXIMUM RATINGS

(Tc=25°C UNLESS OTHERWISE NOTED)

SYMBOL	PARAMETER	CONDITIONS	RATINGS	UNIT
VDSS	Drain to source voltage		50	V
VGSS	Gate to source voltage		+/- 20	V
Pch	Channel dissipation	Tc=25°C	62.5	W
Tj	Junction temperature		150	°C
Tstg	Storage temperature		-40 to +150	°C
Rth-c	Thermal resistance	Junction to case	2.0	°C/W

Note 1: Above parameters are guaranteed independently.

## ELECTRICAL CHARACTERISTICS (Tc=25°C, UNLESS OTHERWISE NOTED)

SYMBOL	PARAMETER	CONDITIONS	LIMITS			UNIT
			MIN	TYP	MAX.	
IdSS	Zero gate voltage drain current	VDS=17V, VGS=0V	-	-	10	uA
IgSS	Gate to source leak current	VGS=10V, VDS=0V	-	-	1	uA
VTH	Gate threshold voltage	VDS=12V, Ids=1mA	1	-	5	V
Pout	Output power	VDD=12.5V, Pin=0.4W,	16	19	-	W
ηD	Drain efficiency	f=30MHz, Idq=0.5A	55	65	-	%
	Load VSWR tolerance	VDD=15.2V, Po=16W(PinControl) Idq=0.5A, Zg=50Ω Load VSWR=20:1(All Phase)	No destroy			-

Note : Above parameters, ratings, limits and conditions are subject to change.



**ELECTROSTATIC SENSITIVE DEVICE**  
OBSERVE HANDLING PRECAUTIONS

MITSUBISHI RF POWER MOS FET

# RD16HHF1

Silicon MOSFET Power Transistor 30MHz,16W

## TYPICAL CHARACTERISTICS

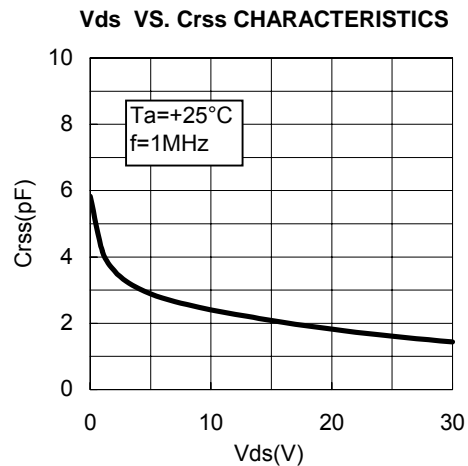
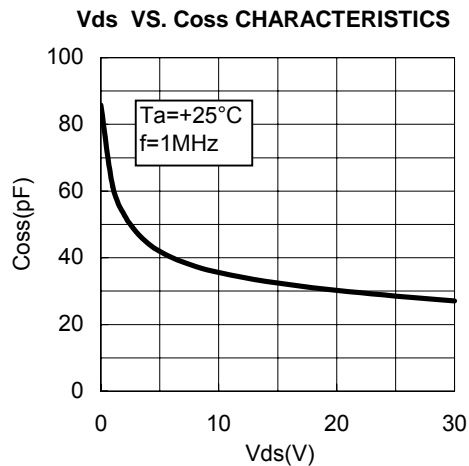
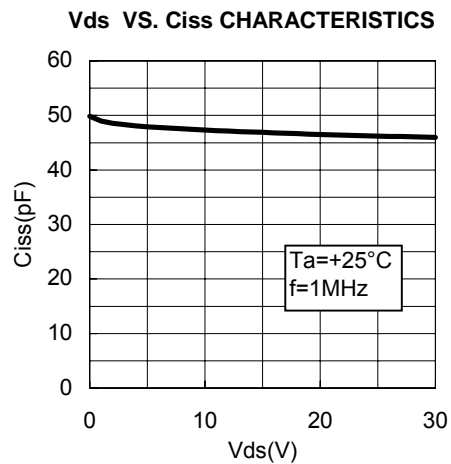
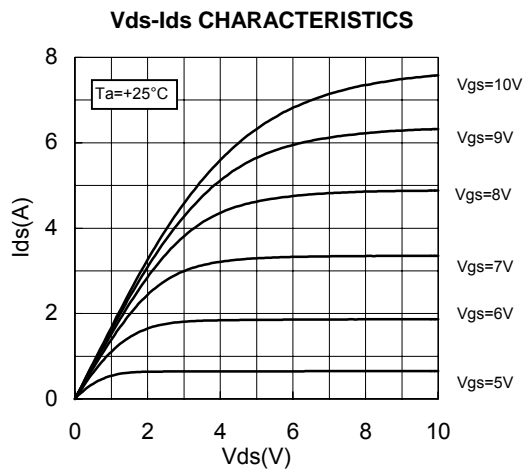
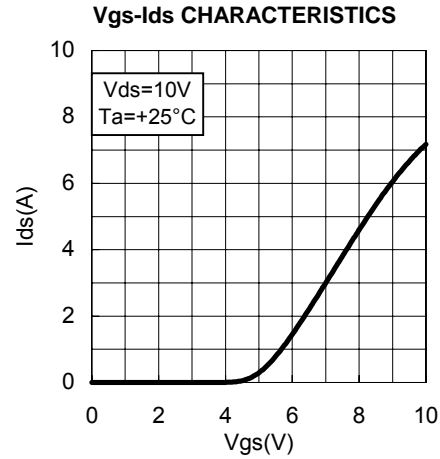
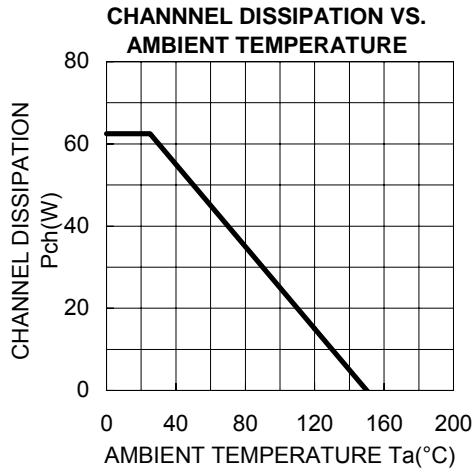

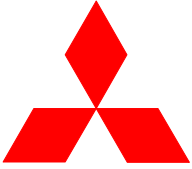

**ELECTROSTATIC SENSITIVE DEVICE**  
OBSERVE HANDLING PRECAUTIONS

MITSUBISHI RF POWER MOS FET

# RD16HHF1

Silicon MOSFET Power Transistor 30MHz,16W

## TYPICAL CHARACTERISTICS

**Pin-Po CHARACTERISTICS**

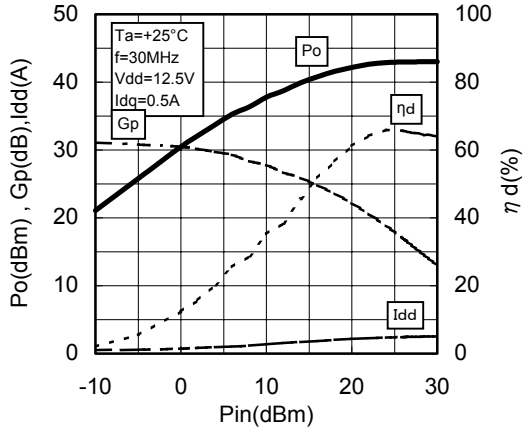

**Pin-Po CHARACTERISTICS**

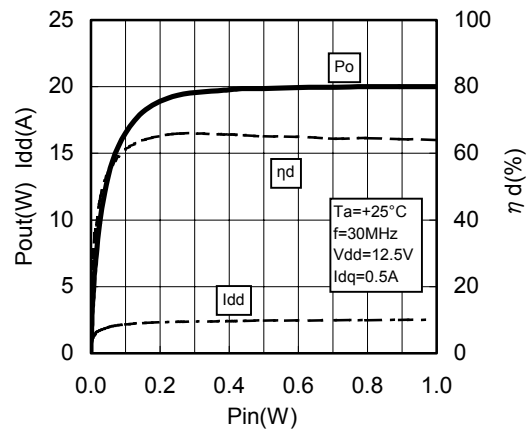

**Vdd-Po CHARACTERISTICS**

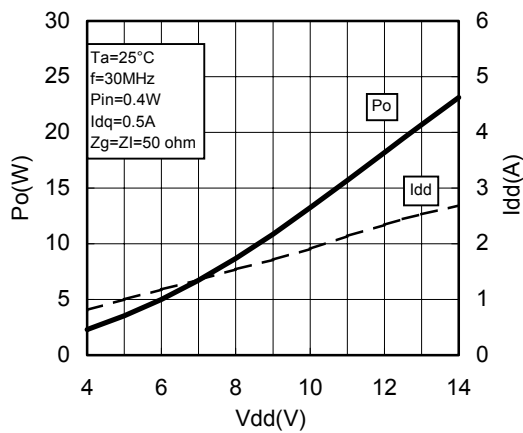

**Vgs-Ids CHARACTERISTICS 2**

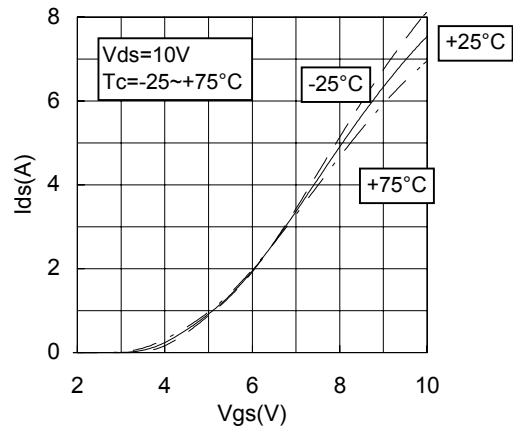

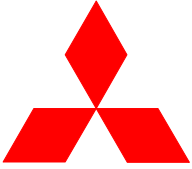

**ELECTROSTATIC SENSITIVE DEVICE**  
OBSERVE HANDLING PRECAUTIONS

MITSUBISHI RF POWER MOS FET

# RD16HHF1

Silicon MOSFET Power Transistor 30MHz,16W

## EQUIVALENT CIRCUIT(f=30MHz)

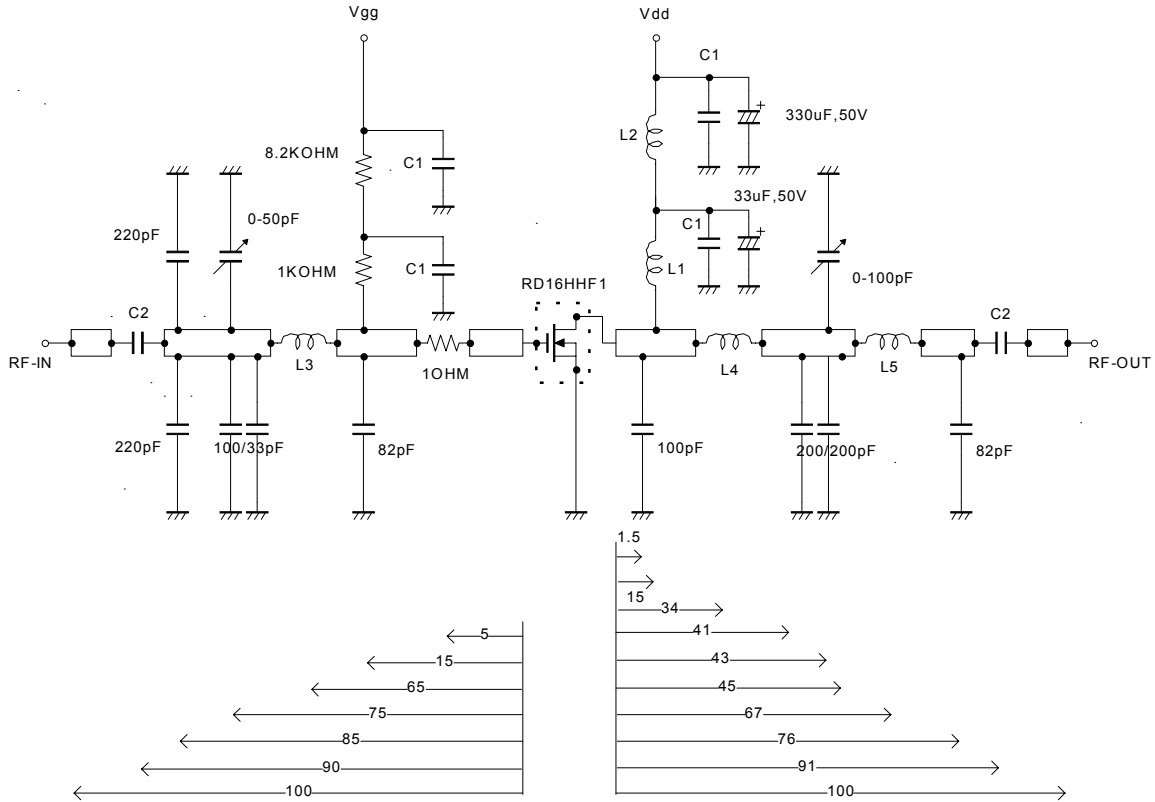

- C1:100pF,0.022uF,0.1uF in parallel
- C2:470uF\*2 in parallel
- L1:10Turns,I.D8mm,D1.0mm UEW
- L2:10Turns,I.D6mm,D1.6mm UEW
- L3:9Turns,I.D5.6mm,D1.0mm UEW

- L4:4Turns,I.D5.6mm,D1.0mm UEW P=0.5
- L5:4Turns,I.D5.6mm,D1.0mm UEW P=1
- Note:Board material-glass epoxy substrate
- Micro strip line width=4.2mm/50OHM,er:2.7,t=1.6mm
- Dimensions:mm

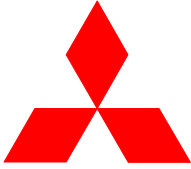

**ELECTROSTATIC SENSITIVE DEVICE**  
OBSERVE HANDLING PRECAUTIONS

MITSUBISHI RF POWER MOS FET

# RD16HHF1

Silicon MOSFET Power Transistor 30MHz,16W

RD16HHF1 S-PARAMETER DATA (@Vdd=12.5V, Id=800mA)

Freq. [MHz]	S11		S21		S12		S22	
	(mag)	(ang)	(mag)	(ang)	(mag)	(ang)	(mag)	(ang)
10	0.928	-43.2	50.035	150.2	0.013	60.6	0.705	-44.6
30	0.761	-96.8	32.680	117.1	0.025	34.3	0.588	-92.6
50	0.676	-121.9	22.018	101.3	0.027	24.3	0.540	-116.9
100	0.650	-145.8	11.543	81.0	0.025	20.3	0.543	-138.4
150	0.679	-156.4	7.560	66.2	0.023	27.0	0.586	-147.1
200	0.709	-162.7	5.380	55.7	0.022	46.4	0.633	-153.2
250	0.742	-168.0	4.126	45.9	0.026	63.2	0.698	-158.1
300	0.775	-173.0	3.208	36.9	0.034	74.4	0.727	-163.2
350	0.801	-177.7	2.592	29.6	0.045	78.3	0.769	-168.0
400	0.826	177.7	2.133	22.6	0.056	78.4	0.805	-172.8
450	0.844	173.2	1.775	16.6	0.069	78.1	0.822	-176.8
500	0.861	169.0	1.509	11.3	0.081	75.3	0.851	178.9
550	0.874	164.8	1.283	5.9	0.093	73.1	0.867	174.7
600	0.884	160.7	1.114	2.1	0.104	69.8	0.877	170.9
650	0.892	156.9	0.974	-1.9	0.117	67.2	0.894	166.9
700	0.900	153.0	0.855	-5.3	0.129	63.7	0.897	163.4
750	0.903	149.1	0.759	-8.4	0.140	60.6	0.904	159.6
800	0.908	145.5	0.678	-11.3	0.150	56.8	0.914	155.9
850	0.912	141.7	0.614	-13.5	0.161	53.8	0.915	152.9
900	0.912	137.9	0.559	-15.3	0.172	50.4	0.917	149.0
950	0.913	134.3	0.509	-17.3	0.180	47.1	0.922	145.4
1000	0.913	130.7	0.467	-17.9	0.190	43.6	0.920	142.4



**ELECTROSTATIC SENSITIVE DEVICE**  
OBSERVE HANDLING PRECAUTIONS

**mitsubishi** RF POWER MOS FET

**RD16HHF1**

**Silicon MOSFET Power Transistor 30MHz,16W**

---

Keep safety first in your circuit designs!

Mitsubishi Electric Corporation puts the maximum effort into making semiconductor products better and more reliable, but there is always the possibility that trouble may occur with them. Trouble with semiconductors may lead to personal injury, fire or property damage. Remember to give due consideration to safety when making your circuit designs, with appropriate measures such as (i) placement of substitutive, auxiliary circuits, (ii) use of non-flammable material or (iii) prevention against any malfunction or mishap.