

## WARRANTY

This radio is covered by a two year limited parts and labor warranty.

- “Limited” means that we will repair problems caused by factory defects or normal use at no charge.
- Before returning a radio to us for warranty service, please call our Service Department for a Repair Authorization Number (RAN). This RAN must be written below your return address on the outside of the shipping box. Boxes, which arrive without a RAN, will be refused, and the shipping company will return the unopened box to you. Be sure to have a pen and paper ready along with the serial number of your radio before calling. We will give you the RAN and our shipping address over the phone. The telephone number of the Service Department is (760) 480-8800, and we suggest calling between 10:00 AM and 4:00 PM Pacific Time.
- Please include a note with a detailed description of the symptoms. This is important because it will help the technician who works on your radio to locate your problem. Intermittent problems are easily overlooked, so be sure to give as much detail as possible in your note. Also, please include your telephone number in case our technicians have any additional questions.
- Do not send your power cord or microphone unless we ask for these items during our telephone conversation.
- You are responsible for getting the radio safely to us. (We suggest using United Parcel Service.) You must pay to ship the radio to us, and we will pay to ship the radio back to you. Since we use UPS and they do not ship to Post Offices boxes, please provide us with a street address for the return of your radio.
- We will repair and return your radio as soon as we can. We appreciate your choosing a Galaxy radio and we want you to be on the air as much as possible!  
Be sure to visit our web site at

[www.GalaxyRadios.com](http://www.GalaxyRadios.com)

Printed In Malaysia  
AT2100013P  
PD000929

# Galaxy

## DX-88HL

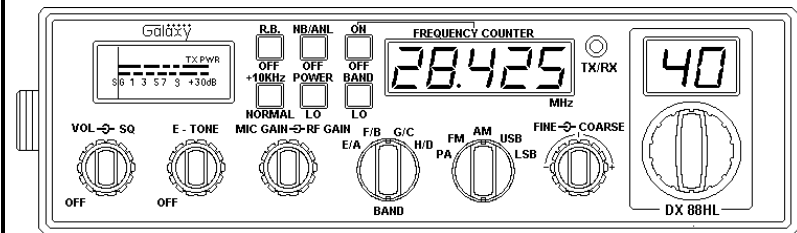

Full Channel AM/FM/SSB Mobile  
Built in Frequency Counter  
AM/FM 10W • SSB 25W with Roger Beep

**OWNER'S MANUAL**

## TABLE OF CONTENTS

Specification .....	Page
<b>Specification</b> .....	2
<b>Installation</b>	
Location .....	4
Mounting the Connection .....	4
Ignition Noise Interference .....	5
Antenna .....	5
Tuning the Antenna for Optimum SWR .....	6
External Speaker .....	7
<b>Operation</b>	
Control Functions .....	8
Front Panel .....	8
Rear Panel .....	11
Press-To-Talk Microphone .....	12
Operating Procedure to Receive. ....	12
Operating Procedure to Transmit .....	12
Receiving SSB Signals .....	13
Roger Beep .....	14
Alternate Microphones and Installation .....	15

## Specifications

### GENERAL

Channels	40 CH
Frequency Range	28.315 to 28.755 MHz
Frequency Control	Phase Lock Loop (PLL) synthesizer.
Frequency Tolerance	0.005%
Frequency Stability	0.001%
Operating Temperature Range	-30°C to +50°C
Microphone	Plug-in dynamic; with push-to-talk switch and coiled cord.
Input Voltage	13.8V DC nominal, 15.9V max, 11.7V min. (positive or negative ground). <i>Transmit:</i> AM full mod., 4A. SSB 25 watts PEP output, 6A <i>Receiver:</i> Squelched, 0.6A Maximum audio output, 1.2A
Size	2-3/8" (H) x 7-7/8" (W) x 9-1/4" (D).
Weight	5 lbs.
Antenna Connector	UHF, SO239
Meter	Illuminated; indicates relative output power, received signal strength and transmit power.

### TRANSMITTER

Power output	AM/FM/ 10 watts. SSB, 25 watts PEP.
Modulation	High-and low-level Class B, Amplitude Modulation: AM. Variable Frequency Modulation: FM.
Intermodulation Distortion	SSB: 3 <sup>rd</sup> order, more than -25dB. 5 <sup>th</sup> order, more than -35dB.
SSB Carrier Suppression	55dB
Unwanted Sideband	50dB
Frequency Response	AM and FM: 450 to 2500 Hz.
Output Impedance	50 ohms unbalanced.
Output Indicators	Meter shows relative RF output power and SWR. Transmit LED glows red when transmitter is in operation.

## RECEIVER

Sensitivity	SSB: 0.25 uV for 10 dB (S=N)/N at greater than ½-watt of audio output. AM: 1.0 uV for 10 dB (S+N)/N at greater than ½-watt of audio output. FM: 1.0 uV for 10 dB (S+N)/N at greater than ½-watt of audio output.
Selectivity	AM/FM: 6 dB @ 3KHz, 50 dB @ 9KHz. SSB: 6 dB @ 2.1KHz, 60 dB @ 3.3KHz.
Image Rejection IF Frequency	More than 65 dB. AM/FM: 10.695 MHz 1 <sup>st</sup> IF, 455 KHz 2 <sup>nd</sup> IF SSB: 10.695 MHz
Adjacent-Channel Rejection	60 dB AM/FM & 70 dB SSB
RF Gain Control	45 dB adjustable for optimum signal reception.
Automatic Gain Control (AGC)	Less than 10 dB change in audio output for inputs from 10 to 100,000 microvolts.
Squelch	Adjustable; threshold less than 0.5 uV.
ANL	Switchable.
Noise Blanker	RF type, effective on AM/FM and SSB
Clarifier Range	Fine (TX/RX) ±1 KHz.
Audio Output Power	4 watts into 8 ohms.
Frequency Response	300 to 2800 Hz.
Built-in Speaker	8 ohms, round.
External Speaker (Not Supplied)	8 ohms; disables internal speaker when connected.

## Installation

### LOCATION

Plan the location of the transceiver and microphone bracket before starting the installation. Select a location that is convenient for operation and does not interfere with the driver or passengers in the vehicles. In automobiles, the transceiver is usually mounted below the dash panel, with the microphone bracket beside it.

### MOUNTING THE CONNECTION

Your transceiver is supplied with a universal mounting bracket. When mounting the bracket and radio to your car, make sure it is mechanically strong. Also provide a good electrical connection to the chassis of the vehicle. Proceed as follows to mount the transceiver:

1. After you have determined the most convenient location in your vehicle, hold the transceiver with mounting bracket in the exact location desired. If nothing will interfere with mounting it in the desired position, remove the mounting bolts. Before drilling the holes, make sure nothing will interfere with the installation of the mounting bolts.
2. Connect the antenna cable plug to the standard receptacle on the rear panel. Most antennas are terminated with a type PL-259 plug and mate with the receptacle.
3. Connect the red DC power input wire (with the fuse) to +13.8V DC. This wire extends from the rear panel. In automobile installation, +13.8V DC is usually obtained from the accessory contact on the ignition switch. This prevents the set being left on accidentally when the driver leaves the car and also permits operating the unit without the engine running. Locate the accessory contact on most ignition switches by tracing the power wire from the AM broadcast receiver in the car.
4. Connect the black lead to -13.8V DC. This is usually the chassis of the car. Any convenient location with good electrical contact (remove paint) may be used.
5. Mount the microphone bracket on the right side of the transceiver or near the transceiver, using two screws supplied. When mounting in an automobile, place the bracket under the dash so the microphone is readily accessible.

## IGNITION NOISE INTERFERENCE

Use of a mobile receiver at low signal levels is normally limited by the presence of electrical noise. The primary source of noise in automobile installations is from the generator and ignition system in the vehicle. Under most operating conditions, when signal level is adequate, the background noise does not present a serious problem. Also, when extremely low level signals are being received, the transceiver may be operated with vehicle engine turned off. The unit requires very little current and therefore will not significantly discharge the vehicle battery.

Even though the transceiver has ANL and NB controls, in some installations ignition interference may be high enough to make good communications impossible. The electrical noise may come from several sources. Many possibilities exist and variations between vehicles require different solutions to reduce the noise.

## ANTENNA

A vertically polarized, quarter-wavelength whip antenna provides the most reliable operation and greatest range. Shorter, loaded-type whip antennas are more attractive, compact and adequate for applications where the maximum possible distance is not required. Also, the loaded whips do not present the problems of height imposed by a full quarter-wavelength whip.

Mobile whip antennas utilize the metal body of the vehicle as a ground plane. When mounted at a corner of the vehicle they are slightly directional, in the direction of the body of the vehicle. For all practical purpose, however, the radiation pattern is nondirectional. The slight directional characteristic will be observed only at extreme distance. A standard antenna connector (type SO239) is provided on the transceiver for easy connection to a standard PL 259 cable termination.

If the transceiver is not mounted on a metal surface, it is necessary to run a separate ground wire from the unit to a good metal electrical ground in the vehicle. When installed in a boat, the transceiver will not operate at maximum efficiency without a ground plate, unless the vessel has a steel hull.

Before installing the transceiver in a boat, consult your dealer for information regarding an adequate grounding system and prevention of electrolysis between fittings in the hull and water.

## TUNNING THE ANTENNA FOR OPTIMUM SWR

Since there is such a wide variety of base and mobile antennas, this section will strictly concern itself to the various types of mobile adjustable antennas.

Because the antenna length is directly related to the channel frequency, it must be tuned to resonate optimally all 40 channels of the transceiver. Channel 1 requires a longer antenna than Channel 40 because it is lower in operates frequency.

Due to the various methods of adjusting antennas for proper SWR we have chosen what we think is the optimum method:

### A. Antennas with adjustment screws (set screws)

1. Start with the antenna extended and tightens the set screw lightly enough so that the antenna can be lightly tapped with your finger for easy adjustment.
2. Set your transceiver to Channel 21 @ C band. Press the PTT (push-to-talk) switch, and tap the antenna (making it shorten). The SWR meter will show a lower reading each time the antenna is tapped. By continuing to shorten the antenna you will notice the SWR reading will reach a low print and then start again. This means that you have passed the optimum point for Channel 21. Extend the antenna a short distance and again follow the procedure above.

When the lowest point has been reached, switch to Channel 1 @ A band or H band and then to Channel 40 @ A band or H band and compare SWR readings. They should be almost equal.

### B. Antennas that must be cut to proper length.

1. Follow the same procedure as above, but adjust the length by cutting in 1/8" increments until a good match is obtained.
2. *Be very careful not to cut too much at one time, as one it is cut, it can no longer be lengthed.*
3. Filing a notch all the way around and breaking the piece off with pliers easily cuts the whip.

#### NOTE

THE PROPER SETTING IS ACHIEVED WHEN THE SWR IS 1.5 OR BELOW, AND WHEN IT HAS THE SAME READING FOR LOW OR HIGH CHANNELS.

If you are having difficulties in adjusting your antenna, check the following:

- A. All doors must be closed when adjusting the antenna.
- B. Make sure the antenna base is grounded.

- C. Check your coaxial cable routing (it may be pinched when routed into the car).
- D. Try a different location on your car (keeping in mind the radiation pattern you wish)
- E. Is the antenna perfectly vertical?
- F. Try a different location in your neighborhood. Stay away from large metal objects when adjusting (metal telephone or light posts, fences, etc.).

**NOTE**

The transceiver will operate into an SWR of 2 to 1 indefinitely and sustain an SWR of 20:1 for a maximum of 5 minutes at rated operating conditions.

**EXTERNAL SPEAKER**

The external speaker jack (EXT.SPK) on the rear panel is used for remote receiver monitoring. The external speaker should have 8 ohms impedance and be able to handle at least 4 watts. When the external speaker is plugged in, the internal speaker is disconnected.

# Operation

**CONTROL FUNCTIONS**

There are fifteen controls and four indicators on the front panel of your transceiver.

**FRONT PANEL**

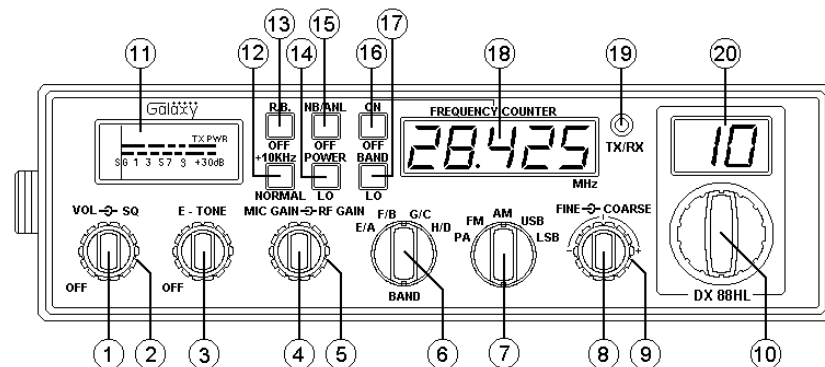

1. **OFF/ON/VOLUME (inner dual concentric):** Turn clockwise to apply power to the unit and to set the desired listening level. During normal operation, the VOLUME control is used to adjust the output level obtained either at the transceiver speaker or the external speaker, if used.
2. **SQUELCH CONTROL (outer dual concentric):** This control is used to cut off or eliminate receiver background noise in the absence of an incoming signal. For maximum receiver sensitivity it is desired that the control be adjusted only to the point where the receiver background noise or ambient backgrounds noise is eliminated. Turn fully counterclockwise then slowly clockwise until the receiver noise disappears. Any signal to be received must now be slightly stronger than the average received noise. Further clockwise rotation will increase the threshold level, which a signal must overcome in order to be heard. Only strong signals will be heard at a maximum clockwise setting.
3. **ECHO (inner dual concentric):** This control is used to echo effect.
4. **TONE (outer dual concentric):** This control is used to intervals of echo sound.

5. **MIC GAIN (inner dual concentric):** Adjusts the microphone gain in the transmit and PA modes. This controls the gain to the extent that full talk power is available several inches away from the microphone.
6. **RF GAIN CONTROL (outer dual concentric):** Use to reduce the gain of the RF amplifier under strong signal conditions.
7. **BAND SELECTOR:** This switch selects A, B, C, D, E, F, G or H band of operation.
8. **MODE (PA/FM/AM/USB/LSB):** This switch is used to select PA, FM, AM, LSB or USB mode of operation. Unless the station with which communication is desired is equipped with SSB, the AM or FM mode is normally used. The mode selector switch changes the mode of operation of both transmitter and receiver simultaneously. Turn to “Receiving SSB signals” for a further explanation of single sideband.
9. **CLARIFIER:** Allows variation of the receiver operating frequencies above and below the assigned frequency. Although this control is intended primarily to tune in SSB signals, it may be used to optimize AM/FM signals as described in the Operating Procedure paragraphs. Coarse operates both TX/RX but Fine only in RX.
10. **CHANNEL SELECTOR:** This switch selects any one of the forty channels desired. The selected channel appears on the LED readout directly above the Channel Selector knob.
11. **METER:** This meter indicates received signal strength, transmitter RF output power and SWR level.
12. **+10KHz FREQUENCY SHIFT SWITCH:** When switch is pressed the frequency is shifted 10KHz up. On following channels. A channel can be used by setting this switch to +10KHz position.

Normal	+10KHz
3	3A
7	7A
11	11A
15	15A
19	19A

13. **ROGER BEEP SWITCH:** When this switch is placed in the ROGER BEEP position, your radio automatically transmits the audio sign at the end of your transmission. The listener can note easily that your transmission is over.

14. **POWER SWITCH:** To select Hi (10 Watts) or Lo (3 Watts) power in AM or FM transmission only.
15. **OFF-NB/ANL SWITCH:** In the NB/ANL position, the RF noise blanker is activated and automatic noise limiter in the audio circuits is also activated. The RF noise blanker is very effective for repetitive impulse noise such as ignition interference.
16. **COUNTER SWITCH-ON/OFF:** Depressing this switch causes the receiver and transmitter frequency to be displayed on the frequency counter.
17. **BAND SWITCH:** This switch is used to select Hi or Lo Band selection.
18. **FREQUENCY COUNTER:** This frequency counter indicates of the selected channel you wish to operate on.
19. **RECEIVE/TRANSMIT INDICATOR:** The receive/transmit LED indicator is located next to the channel indicator. When in receive, the LED will be green. When in transmit the LED will be red.
20. **CHANNEL INDICATOR:** Numbered LED indicates the selected channel you wish to operate on.

## REAR PANEL

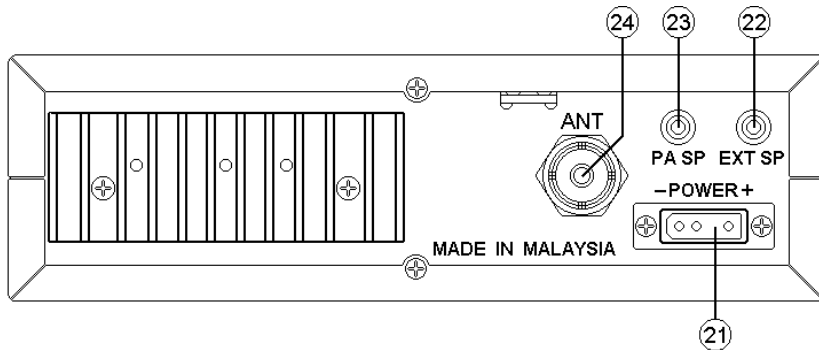

21. **POWER:** Accepts 13.8V DC power cables with built-in fuse (7 amp.) to be connected.
22. **EXT SP:** Accepts 4 to 8 ohms, 5 watt external speaker to be connected. When external speaker is connected to this jack, the built-in speaker is automatically disconnected.
23. **PA. SP:** Used to connect a PA speaker (8 ohm 4W) for PA operation. Before operating PA you must first connect a PA speaker to this jack.
24. **ANTENNA:** Accepts 50 ohm coaxial cable with a type PL-259 plug to be connected.

## PRESS-TO-TALK MICROPHONE

The receiver and transmitter are controlled by the press-to-talk switch on the microphone. Press the switch and the transmitter is activated, release switch to receive. When transmitting, hold the microphone two inches from the mouth and speak clearly in a normal “voice”. The radios come complete with low-impedance (500 ohm) dynamic microphone. For installation instructions on other microphones, see next section, “ALTERNATE MICROPHONES AND INSTALLATION”.

## OPERATING PROCEDURE TO RECEIVE

1. Be sure that power source, microphone and antenna are connected to the proper connectors before going to the next step.
2. Turn unit on by tuning **VOL** control clockwise on your transceiver.
3. Set the **VOLUME** for a comfortable listening level.
4. Set the **MODE** switch to the desire mode.
5. Listen to the background noise from the speaker. Turn the **SQUELCH** control slowly clockwise until the noise **JUST** disappears (no signal should be present). Leave the control at this setting. The **SQUELCH** is now properly adjusted. The receive will remain quiet until a signal is actually received. Do not advance the control too far, or some of the weaker signals will not be heard.
6. Set **CHANNEL** selector switch to the desired channel.
7. Set the **RF** gain control fully clockwise for maximum **RF** gain.
8. Adjust **CLARIFIER** control to clarify the SSB signals or to optimize AM/FM signals.

## OPERATING PROCEDURE TO TRANSMIT

1. Select the desired channel of transmission.
2. Set the **MIC GAIN** control fully clockwise.
3. If the channel is clear, depress the push-to-talk switch on the microphone and speak in a normal voice.

## RECEIVING SSB SIGNALS

There are four types of signals presently used for communications: FM, AM, USB and LSB. When the MODE switch on your unit is placed in the AM position, only standard double-sideband and in FM position, only frequency deviation, full carrier signals will be detected. An SSB signal may be recognized while in the AM or FM mode by its characteristic “Donald Duck” sound and the inability of the AM or FM detector to procedure an intelligible output. The USB and LSB modes will detect upper sideband and lower sideband respectively and standard AM signals.

SSB reception differs from standard AM reception in that SSB receiver does not require a carrier or opposite sideband to produce an intelligible signal. A single-sideband transmitted signal consists only of the upper or lower sideband and no carrier is transmitted. The elimination of the carrier from the AM signal helps to eliminate the biggest cause of whistles and tones heard on channels that make even moderately strong AM signals unreadable. Also, SSB takes only half of an AM channel, therefore two SSB conversations will fit into each channel, expanding the 40 AM channels to 80 SSB channels. The reduction in channel space required also helps in the receiver because only *half* of the noise and interference can be received with 100% of the SSB signal.

An SSB signal may be received only when the listening receiver is functioning in the same mode. In other words, an upper sideband signals (USB) may be made intelligible *only* if the receive is functioning in the USB position.

If a lower sideband (LSB) signal is heard when the receiver is in the USB mode, no amount of tuning will make the signal intelligible. The reason for this may be understood if you consider that when modulation is applied to the transmitter’s microphone in the USB mode, the transmitter’s output frequency is increased whereas in the LSB mode, the transmitter’s output frequency is decreased. The result in listening to the receiver is that when the mode switch is in the proper position (either USB or LSB), a true reproduction of single tone of modulation will result, and if the tone is increased in frequency (such as a low-pitched whistle a high-pitched whistle) you will hear the increase in the output tone of the receiver. If the incorrect mode is selected, an increase in tone of a whistle applied to the transmitter will cause a decrease in the resultant tone from the receiver.

Thus when a voice is used in place of a whistle or tone, in the proper listening mode the voice will be received correctly whereas in the incorrect mode, the voice will be translated backwards and cannot be made intelligible by the voice lock control. When listening to an AM transmission, a correct sideband is heard in either mode since both upper and lower sidebands are received.

Once the desired SSB mode has been selected, frequency adjustment may be necessary in order to make the incoming signal intelligible, the CLARIFIER control allows the operator to vary frequency above and below the exact-center frequency of the received signal. If the sound of the incoming signal is high or low pitched, adjust the operation of the CLARIFIER. Consider it as performing the same function as a phonograph speed control. When the speed is set to high, voices will be high-pitched and if set too low, voices will be low-pitched. Also, there is only one correct speed that will make a particular record procedure the same sound that was recorded. If the record is played on a turntable that rotated in the wrong direction (opposite sideband) no amount of speed control (CLARIFIER) will produce an intelligible sound.

An AM signal received while listening in one of the SSB modes will produce a steady tone (carrier) in addition to the intelligence, unless the SSB receiver tuned to exactly the same frequency by the CLARIFIER control. For simplicity it is recommended that the AM modes be used to listen to AM signals.

## ROGER BEEP

When your transceiver is on normal operation, your radio automatically transmits the audio sign at the end of your transmission. The listener can note easily that your transmission is over through the sign. Please note that this ROGER BEEP transmits 0.15-second at the moment PRESS-TO-TALK SWITCH KNOB is off.

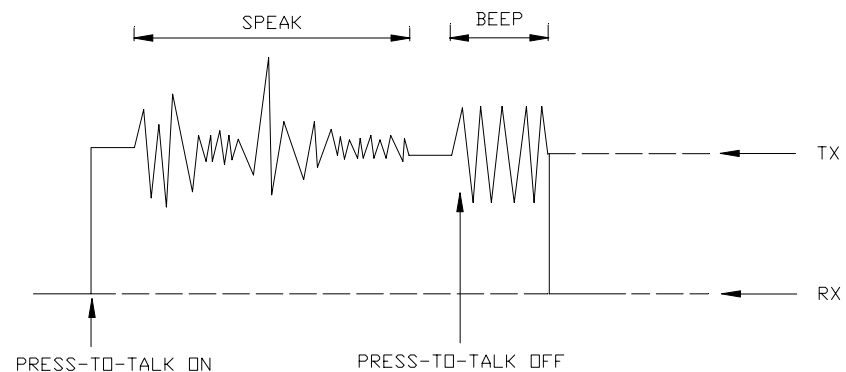

Fig. 2.



## ALTERNATE MICROPHONES AND INSTALLATION

For best results, the user should select a low-impedance dynamic type microphone or a transistorized microphone. Transistorized type microphones have a low output impedance characteristic. The microphones must be provided with a four-lead cable. The audio conductor and its shielded lead comprise two of the leads. The fourth lead is for receiving control, and the third is for transmitting control. The microphone should provide the functions shown in schematic below.

### 4 WIRE MIC CABLE

Pin Number	Mic Cable Lead
1	Audio shield
2	Audio Lead
3	Transmit control
4	Receive Control

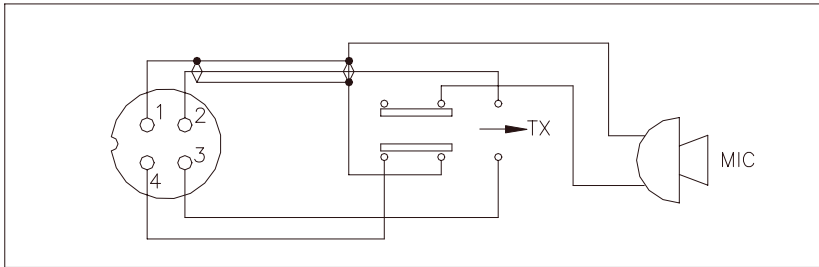
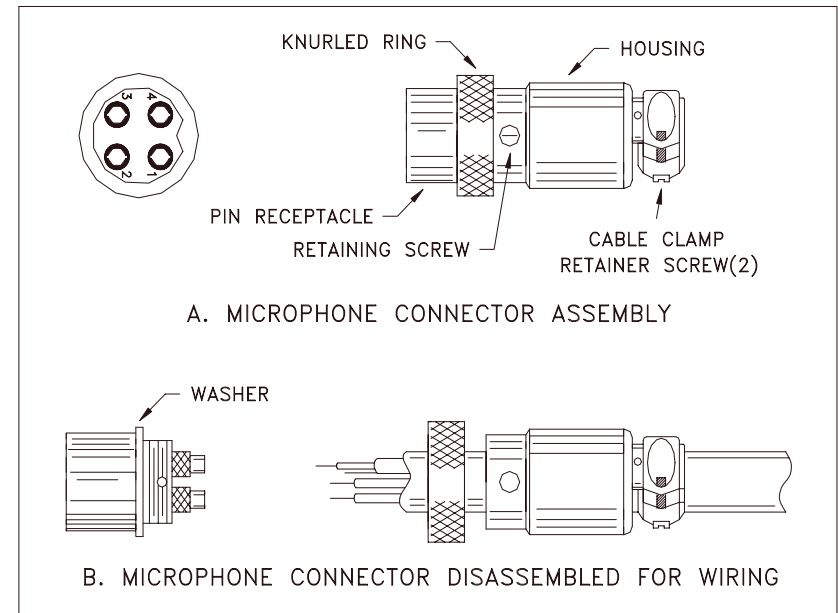

**Fig. 3** Your transceiver microphone schematic.

If the microphone to be used is provided with pre-cut leads, they must be revised as follows.

1. Cut leads so that they extend 7/16" beyond the plastic insulating jacket of the microphone cable.
2. All leads should be cut to the same length. Strip the ends of each wire 1/8" and tin the exposed wire.

Before beginning the actual wiring read carefully, the circuit and wiring information provided with the microphone you select. Use the minimum head required in soldering the connections. Keep the exposed wire lengths to a minimum to avoid shorting when the microphone plug is reassembled.



**Fig. 4** Microphone plug wiring

1. Remove the retaining screw
2. Unscrew the housing from the pin receptacle body
3. Loosen the two cable clamp retainer screws.
4. Feed the microphone cable through the housing, knurled ring and washer as shown Fig. 4.
5. The wires must now be soldered to the pins as indicated in the above wiring tables. If a vise or clamping tool is available it should be used to hold the pin receptacle body during the soldering operation, so that both hands are free to perform the soldering. If a vise or clamping tool is not available, the pin receptacle body can be held in a stationary position by inserting it into the microphone jack of the front panel. The numbers of the pins of the microphone plug are shown in Fig. 5, as viewed from the back of the plug. Before soldering the wire to the pins, pre-tin the wire receptacle of each pin of the plug.

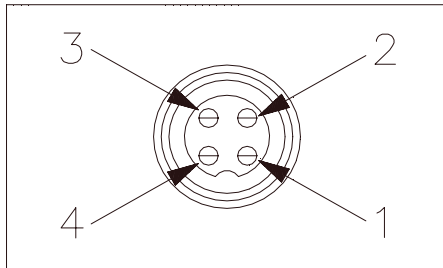

**Fig. 5** Microphone plug pin numbers viewed from rear of pin receptacle.

Be sure that the housing and the knurled ring of Fig. 4 are pushed back onto the microphone cable before starting to solder. If the washer is not captive to the pin receptacle body, make sure that it is placed on the threaded portion of the pin receptacle body before soldering.

If the microphone jack is used to hold the pin receptacle during the soldering operation, best results are obtained when the connections to pins 1 and 3 are made first and then the connections to pins 2 and 4. Use a minimum amount of solder and be careful to prevent excessive solder accumulation on pins, which could cause a short between the pin and the microphone plug housing.

6. When all soldering connections to the pins of the microphone plug are complete, push the knurled ring and the housing forward and screw the housing onto the threaded portion of the pin receptacle body. Note the location of the screw clearance hole in the plug housing with respect to the threaded hole in the pin receptacle body. When the housing is completely threaded into the pin receptacle body, a final fraction of a turn either clockwise or counterclockwise may be required to align the screw hole with the threaded hole in the pin receptacle body. When these are aligned, the retaining screw is then screwed into the place to secure the housing to the pin receptacle body.
7. The two cable clamp retainer screws should now be tightened to secure the housing to the microphone cord. If the cutting directions have been carefully followed, the cable clamp should secure to the insulating jacket of the microphone cable.
8. Upon completion of the microphone plug wiring, connect and secure the microphone plug in the transceiver.

## WARRANTY

**This radio is covered by a two year limited parts and labor warranty.**

- “Limited” means that we will repair problems caused by factory defects or normal use at no charge.
- Before returning a radio to us for warranty service, please call our Service Department for a Repair Authorization Number (RAN). This RAN must be written below your return address on the outside of the shipping box. Boxes, which arrive without a RAN, will be refused, and the shipping company will return the unopened box to you. Be sure to have a pen and paper ready along with the serial number of your radio before calling. We will give you the RAN and our shipping address over the phone. The telephone number of the Service Department is (760) 480-8800, and we suggest calling between 10:00 AM and 4:00 PM Pacific Time.
- Please include a note with a detailed description of the symptoms. This is important because it will help the technician who works on your radio to locate your problem. Intermittent problems are easily overlooked, so be sure to give as much detail as possible in your note. Also, please include your telephone number in case our technicians have any additional questions.
- Do not send your power cord or microphone unless we ask for these items during our telephone conversation.
- You are responsible for getting the radio safely to us. (We suggest using United Parcel Service.) You must pay to ship the radio to us, and we will pay to ship the radio back to you. Since we use UPS and they do not ship to Post Offices boxes, please provide us with a street address for the return of your radio.
- We will repair and return your radio as soon as we can. We appreciate your choosing a Galaxy radio and we want you to be on the air as much as possible!

Be sure to visit our web site at

[www.GalaxyRadios.com](http://www.GalaxyRadios.com)